

The GENESIS Project

This information is free. It may not be used for a patent, trademark or any ownership whatever. Please distribute without alteration as widely as possible. This information comes from www.geocities.com/nayado.

Document date: March 1999

INTRODUCTION

The history of mankind has recorded continuous destruction. Creation always brings more powerful destruction. The reason is that the world is inevitably regulated by physical laws.

Existing physics tells us that destruction faces the same direction as time-flow. To prevent destruction radically, we have to find a new time-flow of creation in the field of physics. In other words, by generating energy from nothing, as the perpetual mobiles described in science fiction.

But, as a matter of fact, nothing can be generated from nil. Thermodynamics perfectly proves the truth. The study, which says that no perpetual mobiles can exist, is based on an ordinary world view, that is, positive-energy is all.

Recently, some theoretical physicists have begun to consider a concept of imaginary time and/or negative-energy. If the negative-energy can exist absolutely, energy concept in physics should be changed and extended to a negative-sphere. Then, it is consequent that perpetual mobiles exist. Provided the perpetual mobiles exist, people, for the first time, can be kept away from destruction.

Thus, in order to change destruction into creation, first of all the mechanism of generating negative-energy should be cleared. That is the aim of Genesis.

A new idea mainly related to electromagnetics is introduced here. Clearing the process of the electromagnetic phenomena occurring with imaginary time, it gives a hint of the concrete measures of separating and generating positive/negative-energy from nil.

No similar thesis has appeared so far and there is no study to affirm the perpetual mobiles along the scientific theory without contradictions. Of course, the perpetual mobile itself has never existed until now.

Genesis lets the era which everybody can enjoy infinite energy and materials in, come up to this world. On that day, your old outlook on the world will break down completely.

By sending an electric current into the non-inductive coil around which electrified into negative, it is possible to induce the opposite self-induction phenomenon. In this time, positive and negative energy are pulled apart from nil. The positive energy appears as an electric power, and the negative energy appears as the effect of cooling and anti-gravity.

FIELD OF NEGATIVE ENERGY

A free electron is an electron which is separated from the nucleus because of a weak binding force. An atom is electrically neutral, so it turns into a positive ion provided that it loses the electron of negative electric charge.

A conduction current is the relative flow between the free electrons and the ion atoms. So the electric current from the viewpoint of the free electrons is the flow of the ion atoms. On the contrary, from the viewpoint of the ion atoms, it is the flow of the free electrons. In comparing these two currents, they flow in opposite directions, but have the same quantity and a reverse pole. That is, the amperages measured by both sides are equal. Therefore, the magnetic field observed by the free electrons equals to the one observed by the ion atoms.

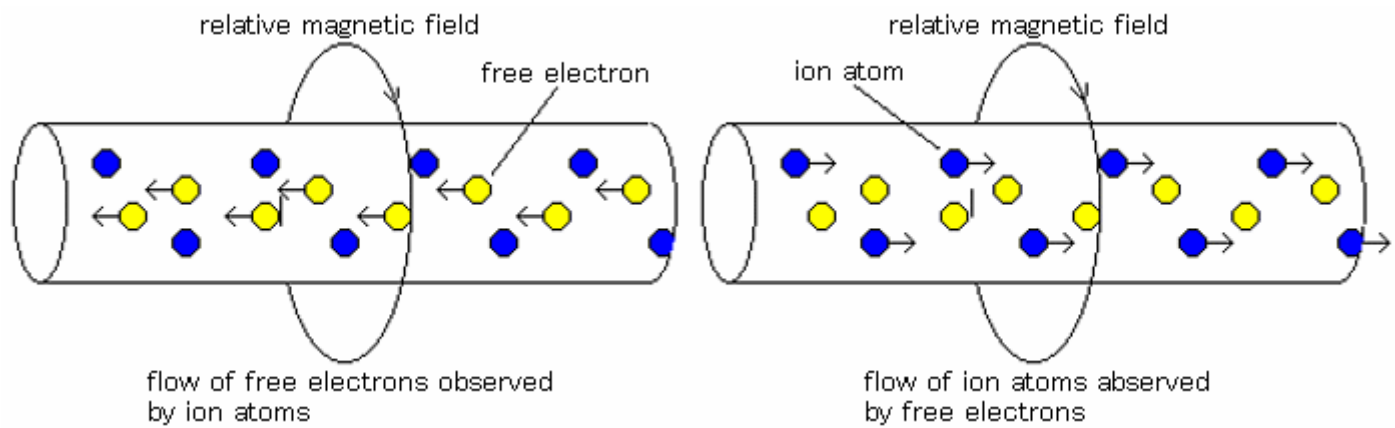

FIGURE 1. conduction current

When the conduction current changes, in other words, when the relative flow quantity between the free electrons and the ion atoms changes, the variation of the magnetic field caused by the change of the flow quantity of the ion atoms observed from the viewpoint of the free electrons are equal to the variation of the magnetic field caused by the change of the flow quantity of the free electrons observed from the viewpoint of the ion atoms. So the electric field induced by the variation of the magnetic field observed from the viewpoint of the free electrons can be observed in the same direction as the electric field induced by the variation of the magnetic field observed from the viewpoint of the ion atoms. Electric fields which have same direction observed from the each viewpoints of the electrons and the ion atoms exert forces in opposite directions to the free electrons and the ion atoms, and prevent the relative flow quantity between the free electrons and the ion atoms from changing.

The above is a new interpretation based on the general principle of relativity about a conduction current, a magnetic field and an induced electric field. From this interpretation, such a basic principle can be suggested as the objectified electric/magnetic charge and its motion cannot be recognised to exist electromagnetically unless they are related with other electric/magnetic charge. We call this The background principle of electromagnetic charge. From it, a self-induction can be considered to be a relative phenomenon between the electric charges. The induced electric field does not result in an electric charge accelerating by itself. Only when the electric charge accelerates compared to another charge, the induced electric field appears. In comparison, Mach's principle an inertial gravitational field appearing in an accelerating mass is caused by another mass existing in the background; Whole Universe which can be considered a background principle of mass.

It follows from the background principle of electromagnetic charge that energy stored in the relative magnetic field between the positive and the negative electric charges is caused by their relative self-induction phenomenon. When the self-induction occurs, the current works positively toward the space, provided that the current and the induced electric field are in opposite directions. If both of them are in the same direction, on the contrary, the space works positively toward the current. In the former situation, the relative flow quantity between the different kind of electric charges would increase, and in the latter, it would decrease. After all, the energy stored in the relative magnetic field between the positive and the negative electric charges is positive. Normal conduction current is equal to it.

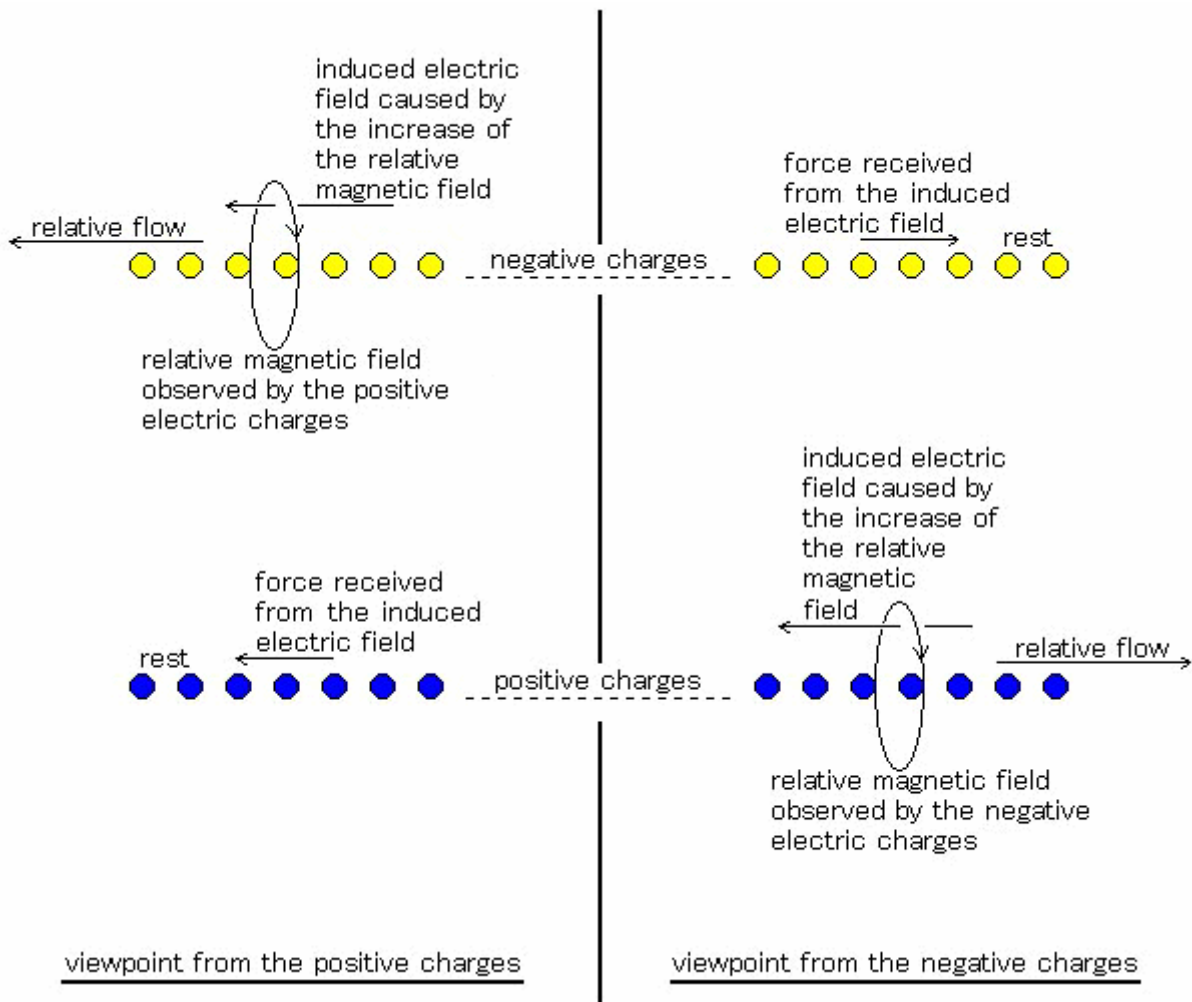

FIGURE 2. self-induction phenomenon appearing relatively between the positive charges and the negative charges accelerating

It follows from the background principle of electromagnetic charge that energy stored in the relative magnetic field between the same kind of electric charges is caused by their relative self-induction phenomenon. When the relative flow quantity between the same kind of electric charges changes, the force that each electric charge receives from the induced electric field is in the direction which accelerates the change of the relative flow quantity. Because the direction is the opposite of a normal self-induction, we call it opposite self-induction. When the relative flow quantity between the same kind of electric charges increase, the space works positively toward the relative flow between the electric charges. On the contrary, when it decrease, the relative flow between the electric charges works positively toward the space. After all, the energy stored in the relative magnetic field between the same kind of electric charges is negative.

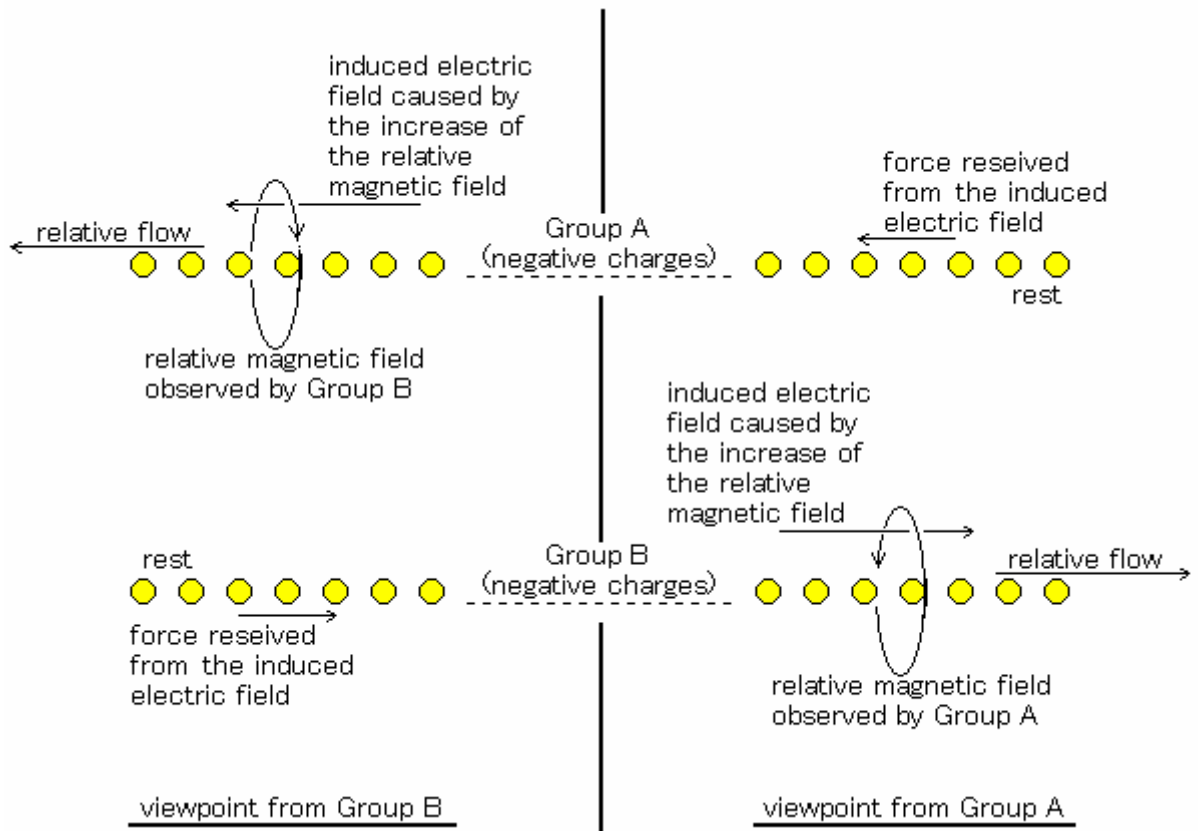

Figure 3a. opposite self-induction phenomenon appearing relatively between the same kind of charges accelerating

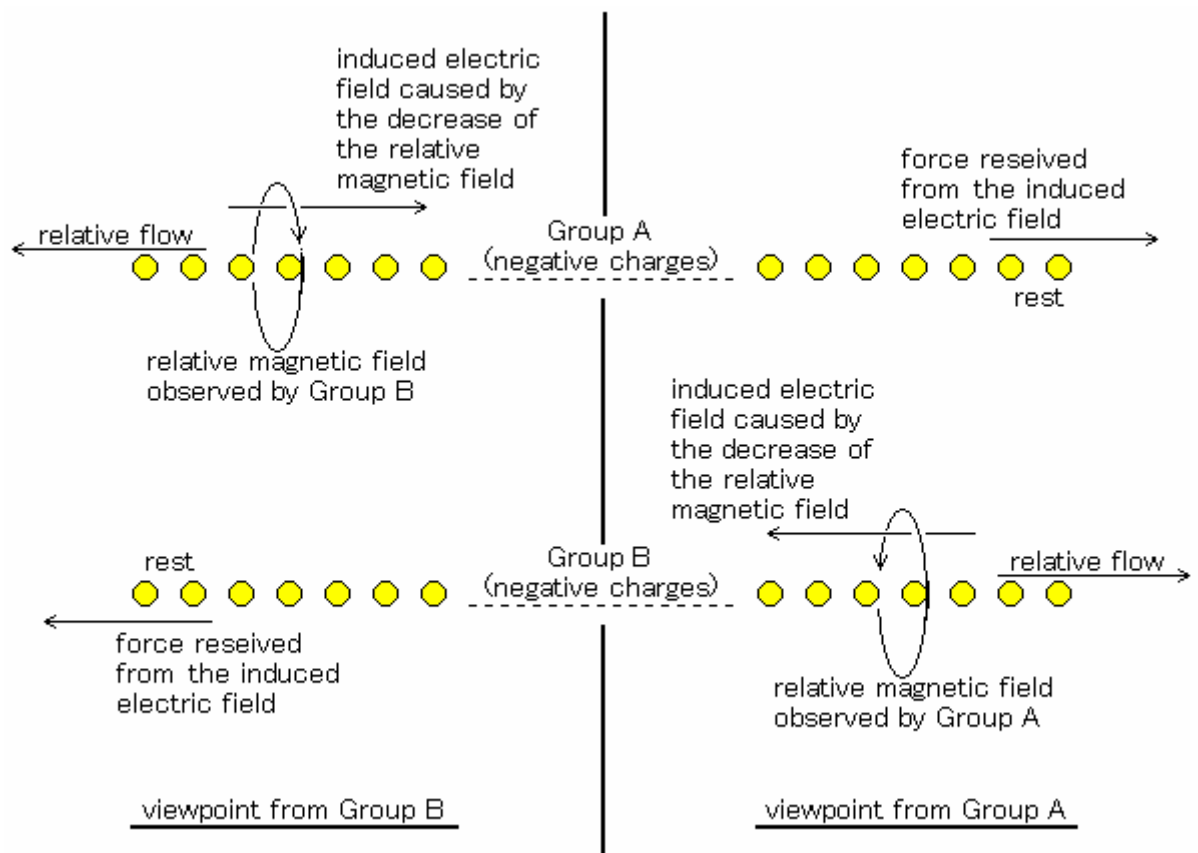

Figure 3b. opposite self-induction phenomenon appearing relatively between the same kind of charges decelerating

the negative energy is a energy or a matter which follows an imaginary time.

From the Dirac equation, the energy of a particle (a electron) can be positive or negative.

$$E = \pm c \sqrt{k^2 + m^2 c^2}$$

The negative energy is excluded from physical subjects, as it is not realistic. But is it truly unrealistic? Let's find the conditions when the signs should be negative among some popular equations .

Energy stored in a coil $E = 1/2 \cdot L I^2 = 1/2 \cdot L (Q/t)^2$

Kinetic energy $E = 1/2 \cdot m v^2 = 1/2 \cdot m (d/t)^2$

Energy equivalent to a mass $E = m c^2$ $c = 2.997 \times 10^8$ [m/sec]

In order to make the signs be negative, it is cleared that the time should be an imaginary number and the space should be a real number.

Then, provided that an object belongs to an imaginary time and a real space, what kind of motion does it make toward the external force? Judging from the equation of motion, the object will accelerate in the opposite direction toward the force received. For example, when the matter receives a downward gravity , it accelerates upward.

$$F = m \alpha \quad m < 0, \quad \alpha \text{ [m/sec}^2\text{]} < 0$$

By the way, considering opposite self-induction particularly, in the condition when the electric charge of a rest system observes the charge of a kinetic system, it is clear that the direction of the virtual force which the induced electric field appearing in the rest system should give to the one of the kinetic system is opposite to the direction of the force (the direction of the charge accelerating) which the charge of the kinetic system receives actually.

NEGATIVE INDUCTOR

As a result of interpretation along the general principle of relativity, it can be found that the opposite self-induction phenomenon is caused by the change of the relative flow quantity between the same kind of electric charges. In applying the phenomenon, it would be possible to generate an electric power from a space while making the entropy decrease. So, I will now introduce a basic circuit element to do that.

A conduction current is the relative flow between the free electrons bearing negative charges and the ion atoms bearing positive charges. In short, it is the relative flow between the different kind of charges. On this occasion, a normal self-induction occurs. In order to produce an opposite self-induction in the conduction current, it is necessary to make a relative flow between the same kind of electric charges. To do it, the positive ion atoms should be changed into the negative ion atoms , or the free electrons should be changed into the positrons. However it is impossible to be realised judging from the constructions of the materials. Also a trial, to bring the relative flow between the same kind of charges by electrifying the surroundings of the conductor into negative, is unrealistic. The reason is that it is necessary to concentrate the negative charges closely to the conductor contrary to the Coulomb force. Furthermore a greater quantity of the negative charges than of the positive charges of the ion atoms in the conductor is needed. Of course, it is impossible.

First, let's envision a conduction current which would not bring the self-induction. This means the current without its magnetic field, that is, the two-way currents. When two kinds of currents, that have the same quantity and the opposite directions, flow into the tightly fit two electric wires one by one, the magnetic fields never appear to be resisting each other. Thinking these double-wires as a single conductor, from the viewpoint of the ion atoms, the flow quantity of the free electrons flowing to the left is equal to the one flowing to the right. Accordingly, the magnetic field does not appear from the viewpoint of the ion atoms. Thinking of this condition from the sight of the free electrons flowing to the left, half as many the free electrons as the ion atoms flow to the right at double the speed of the ion atoms. That is, the flow quantity of the free electrons is equal to the one of the ion atoms. Accordingly, the magnetic field does not appear as well from the viewpoint of the free electrons flowing to the left. On the other hand, considering the situation from the sight of the free electrons flowing to the right, half as many the free electrons as the ion atoms flow to the left at double the speed of the ion atoms. That is, the flow quantity of the free electrons is equal to the one of the ion atoms. Accordingly, the magnetic field does not appear as well from the viewpoint of the free electrons flowing to the right.

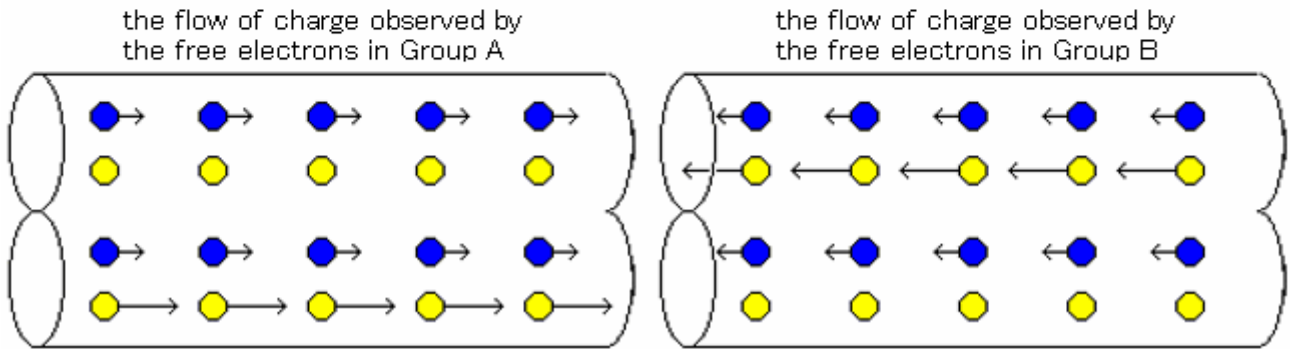
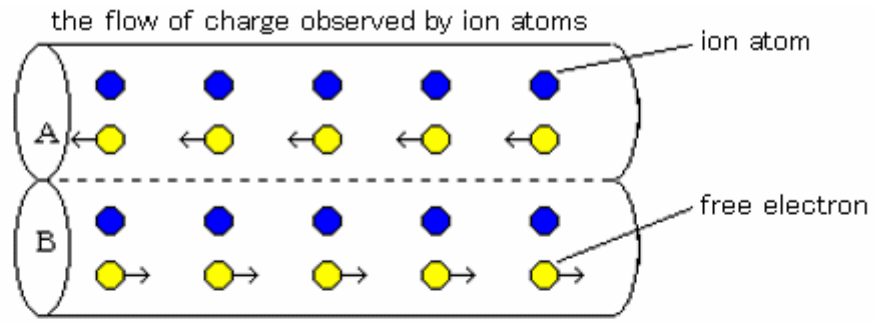
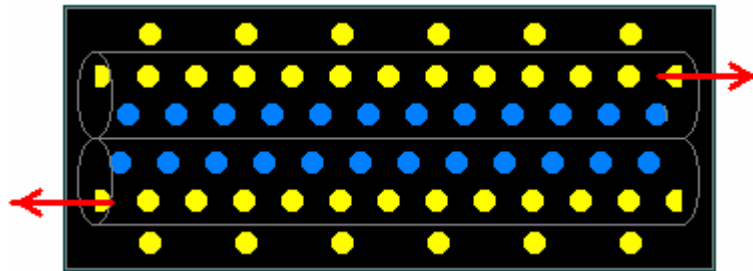

Figure 4. relative flow of charges in double electric wires
(In each case, magnetic field does not appear.)



Assume that two currents with the same quantity in the opposite directions flow in the double electric wires. When the currents change, the variation of the flow quantity of the positive electric charges is always equal to the variation of the flow quantity of the negative electric charges in the background of the flowing free electrons. Accordingly, the variation of the flow quantity of electric charge occurring in the background of the free electrons do not bring any variations of the magnetic field. Without the variation of the magnetic field, the induced electric field cannot appear. At this time, the relative self-induction doesn't occur between the free electrons flowing and the background.

When the current changes under the condition that the background of the double electric wires is charged into negative, the relative flow quantity changes between the free electrons flowing in the conductors and the free electrons being in the background. That is, it is possible to change the relative flow quantity of the same kind of charges. At this time, the opposite self-induction phenomenon with a negative energy appears.

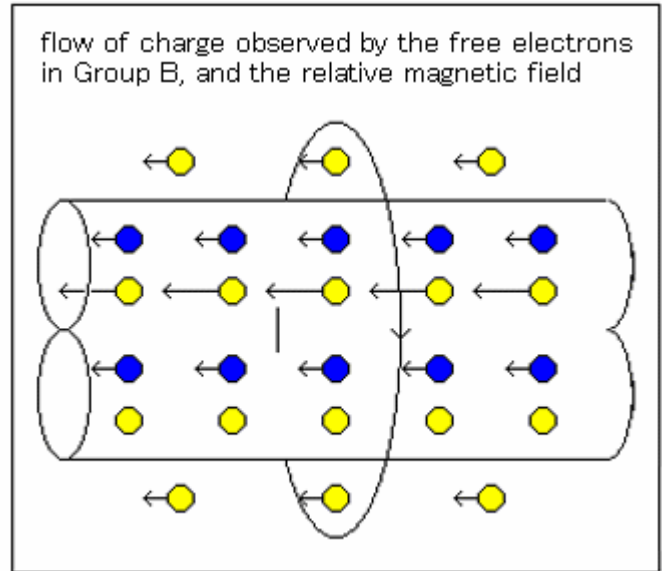
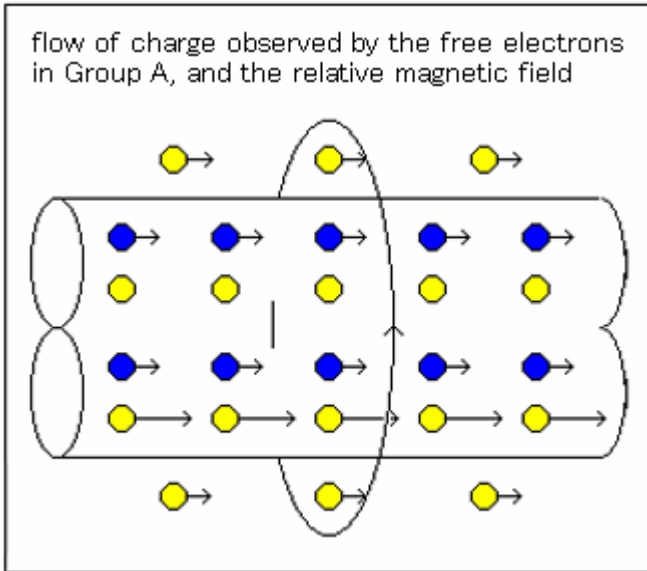
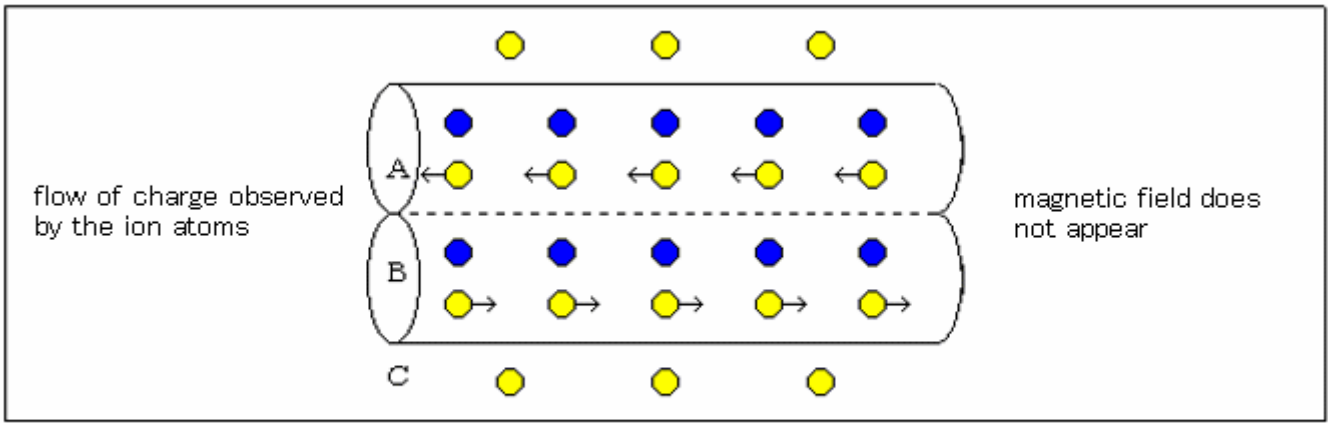

Figure 5. When the background of double electric wires are electrified into negative, magnetic fields with negative energy appear at the viewpoints of free electrons in Group A and Group B by opposite-self-induction.

Double coils can be made by winding up the two electric wires to the magnetic core. After we electrify the magnetic core into negative, we flow the electric current in the double coils, just then the relative opposite self-induction phenomenon appears between the free electrons attached to the magnetic core and the free electrons flowing in the double-coils. As a result of that, a negative energy can be stored in the surroundings where the relative magnetic field appears. We give the name negative inductor to the inductor which consists of the magnetic core electrified into negative and the double coils (non-inductive coil) in which the currents with the same quantity and the opposite directions flow.

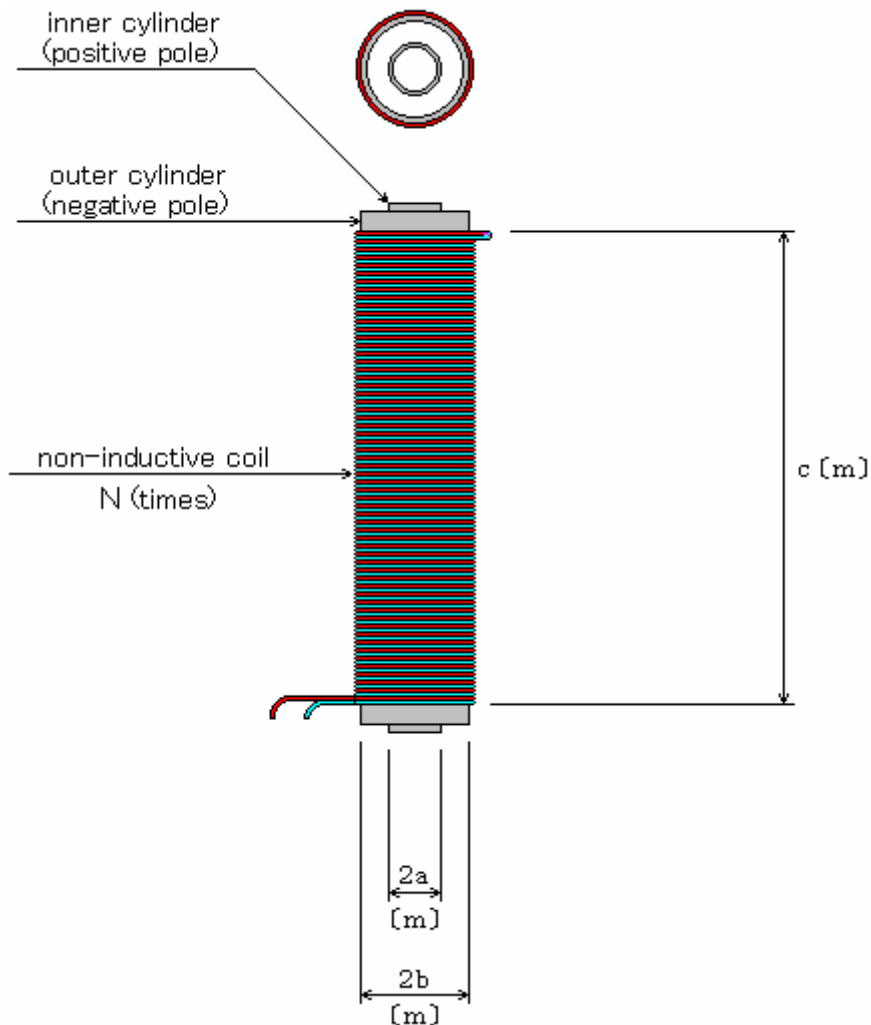

Figure 6. NEGATIVE INDUCTOR

Figure 6 is a sample of the simplest negative inductor. In order to increase the electrostatic capacity of the magnetic core, two aluminium cylinders with different diameters are set coaxially as a magnetic core. Winding up the two immediate enamelled wires thickly to the outer cylinder (in the chart, a wire is indicated with blue, another with red), the ends of one of the wires close and the ends of other open. The two opened ends become the connecting terminals of the negative inductor. To make the relative magnetic field which is observed from the free electrons flowing in the coil, appear in the direction which brings the opposite self-induction, it is necessary to electrify the outer cylinder into negative and the inner cylinder into positive. If the cylinders are charged with the opposite polarities, the positive inductance occurs in the double coils.

In **Figure 6**, the conditions are as follows ; $a = 0.03(\text{m})$, $b = 0.05(\text{m})$, $c = 1.2(\text{m})$, the semi-diameter of the electric wire (copper) forming the coil $d = 1 \times 10^{-4} (\text{m})$, the applied voltage to the magnetic core $3 \times 10^4 (\text{V})$, the inner cylinder is electrified into positive and the outer cylinder into negative. And the two connecting terminals close. Provided that the double coils of this negative inductor is boosted with 500 Volts, the electromotive force of the opposite self-induction is 15 Volts in the initial time.

The direction of the electromotive force of the opposite self-induction induced in the increasing current is equal to the direction of the initial applied voltage. Accordingly, in the situation above, at the same time that the initial voltage 500 Volts is applied, the total voltage reaches 515 Volts instantly. Then, much larger currents and electromotive forces in the direction which helps the current increasing is induced. With such endless inductions, the current can easily reach the physical limit point in a short time. And when the current is made decrease by handling the voltage, the electromotive force in the direction which helps the current decreasing is induced, and after the current reaches zero instantly, the current begins to accelerate in the opposite direction rapidly.

The negative inductance of the negative inductor is proportional to the product of the rate of change of the relative magnetic fluxes piercing the coil and the number of turns of the coil, like the general inductor. By raising the voltage applied on magnetic core, the total number of the relative magnetic fluxes piercing the double-coils can be increased.

In order to actuate the circuit including the negative inductor, it is necessary to cancel the magnetic fields as much as possible in the circuit, for keeping the total inductance of the circuit negative.

The negative inductor stores a negative energy in a space where the relative magnetic field appears, and as a counteraction, the inductor generates an electric power with a positive energy. The free electrons which got a kinetic energy from a space as accelerating returns the kinetic energy to the space as decelerating. In a normal conductor, the free electrons lose the kinetic energy by colliding with the atoms. In this case, the atoms which enhanced their vibration energy by the collisions with the free electrons radiate heat. In the electric wire of the negative inductor, the kinetic energy of the electrons go in and out the space, so that the electrons influence the atoms just a little. For this reason, the free electrons work to buffer the thermal vibrations of the atoms. That is, the negative inductor becomes cool in the actuation. The same phenomenon occurs in a conductor just charged into negative as well. Though the free electrons in the conductor are making motions in their random directions while colliding with the atoms, these free electrons cancel out each other's speed, so the current does not appear macroscopically. This situation is equal to the one in which the two currents with the same quantity and different directions flow into the non-inductive double coils. Provided that the conductor electrifies into negative, each free electron making the thermal motion can bring the opposite self-induction while accelerating or decelerating. Accordingly, the conductor with a negative charge is refrigerated, and the field of negative energy appears in the surroundings. Thus the conductor which become negatively charged can be considered as a negative conductor which is working.

Our future tasks are to develop perpetuum mobiles using the negative inductor and to study the effect of anti-gravity brought by the negative inductor.

SAMPLES OF NEGATIVE INDUCTOR

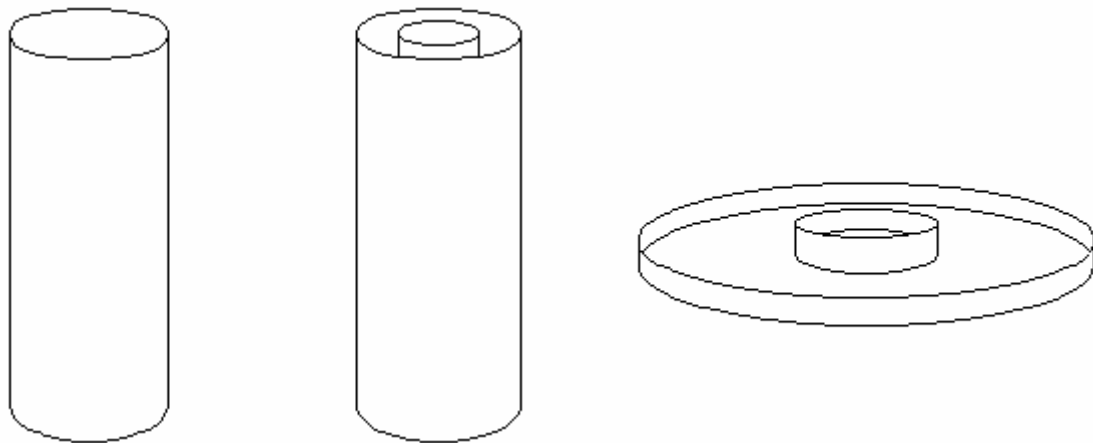

Figure 7. A single cylinder (electrifying in negative) A double cylinders (the inner cylinder electrifying in positive, and the outer cylinder in negative)

Sample of the magnetic core used in the negative inductor, the solenoid-type. Double coils wind around the cylinder electrifying in negative.

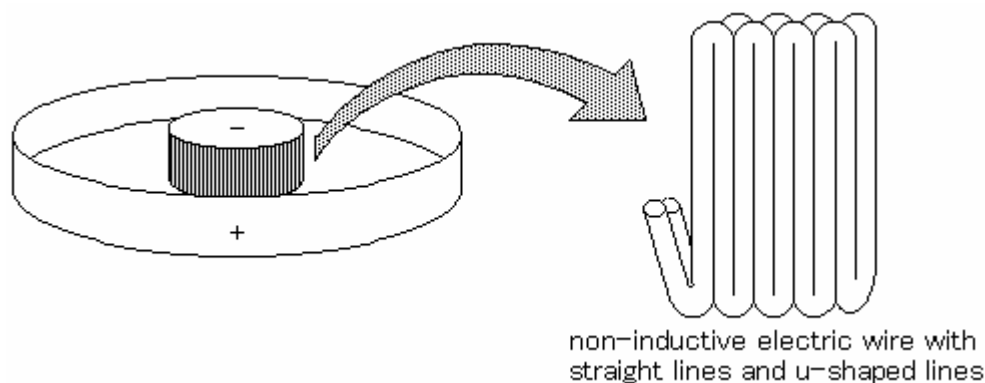

Figure 8.

The magnetic core used in the negative inductor, the toroidal-type. The inner cylinder is electrified into negative, and the outer cylinder is electrified into positive. The non-inductive electric wire are placed on the surface of the inner cylinder along the circumference in the direction of the axis. The non-inductive electric wire are not placed on the outer cylinder. For free electrons flowing in the direction of the axis of the cylinder, the electrifying double cylinders are equal to a toroidal coil.

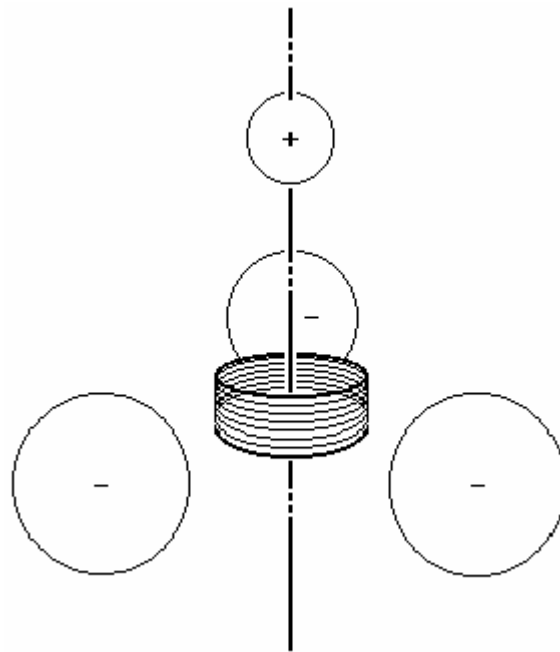
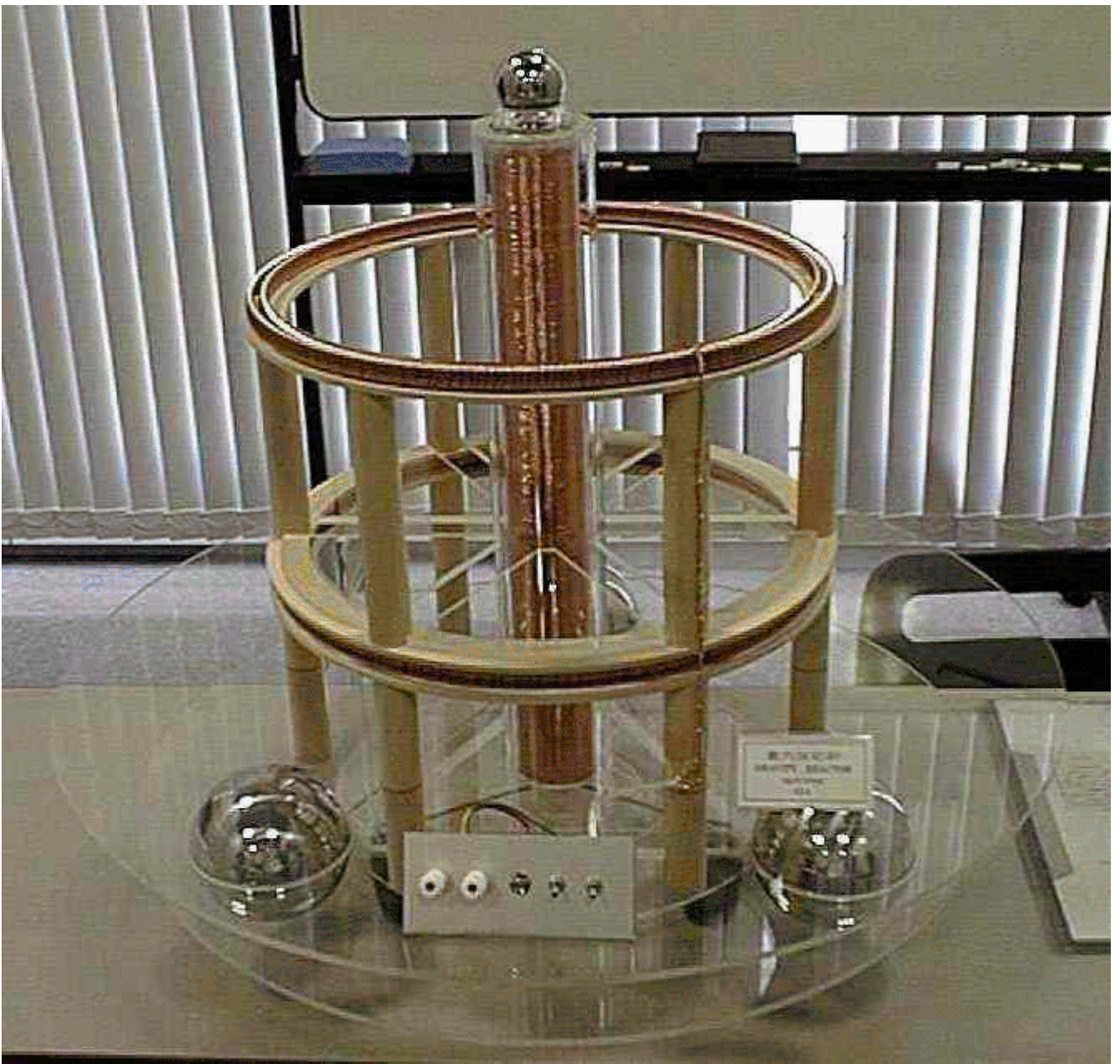
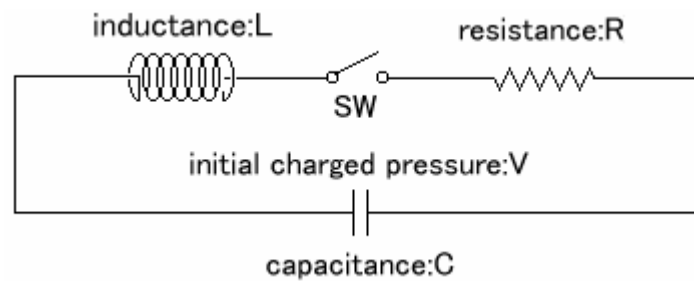

Figure 9.

Setting metallic balls which are electrified into negative, symmetrically around the axis of the double coils (non-inductive coil). Setting other smaller metallic ball which is electrified into positive, on the axis detached from the coil. Because the non-inductive coil doesn't generate the magnetic field, at the viewpoint of the free electrons flowing in the coiled wire, there is nothing but the magnetic field caused by the electrifying balls in circular motion. This relative magnetic field pierces the coil, and induces an opposite self-induction phenomenon.



The Self-Excited Generator



RLC series circuit is popular as an electric oscillation circuit.

In this circuit, on the condition that the switch turns on after the capacitor is charged, when $R < 2\sqrt{L/C}$ the oscillating current occurs as the following .

$$I = \frac{V}{\sqrt{(L/C) - (R^2/4)}} e^{-\alpha t} \sin \omega t \quad (\text{equation 1})$$

The conditions are;

e is the base of natural logarithm, e = 2.7182

a is the attenuation constant, $a = R/2L$ (the reciprocal of the time constant)

The current becomes the damped oscillation shown in **Figure 11**.

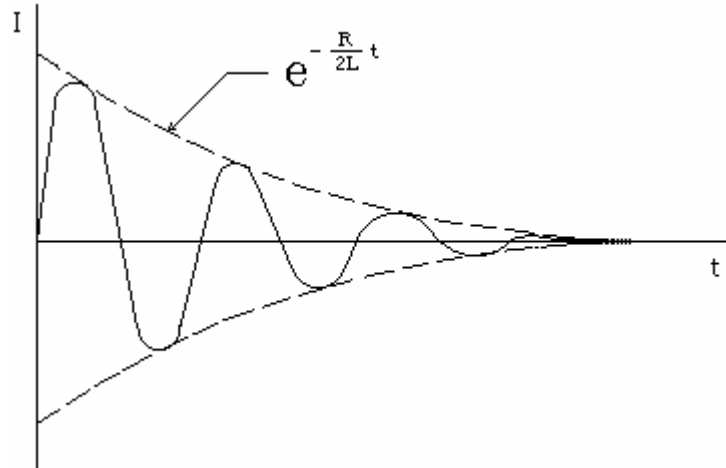

Figure 11. damped oscillation

When the resistance $R=0$, the attenuation constant $a = 0$. In this situation, the current becomes the sustained oscillation shown in **Figure 12**.

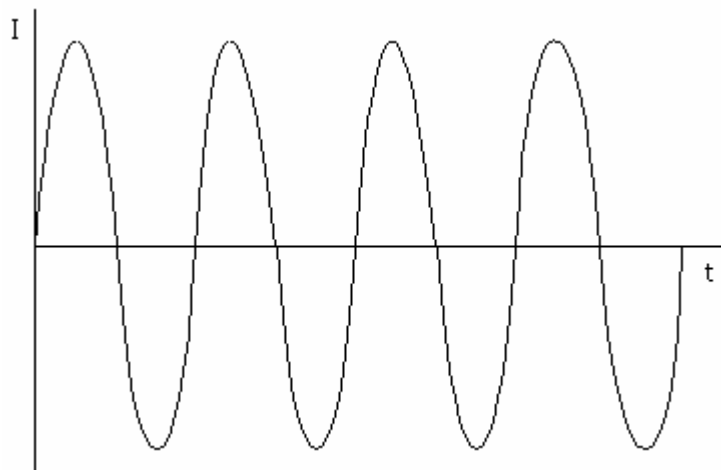

Figure 12. sustained oscillation

Then, in the RLC series circuit, on the condition that the inductance L is negative, what kind of current flows? Interestingly, a is a negative value, and the increased oscillation shown in **Figure 13**. occurs under the conditions to oscillate satisfied. At this time, according to the equation 1, because the number in the radical sine is negative, the value of current becomes an imaginary number. In other words, the motions of free electrons follow an imaginary time.

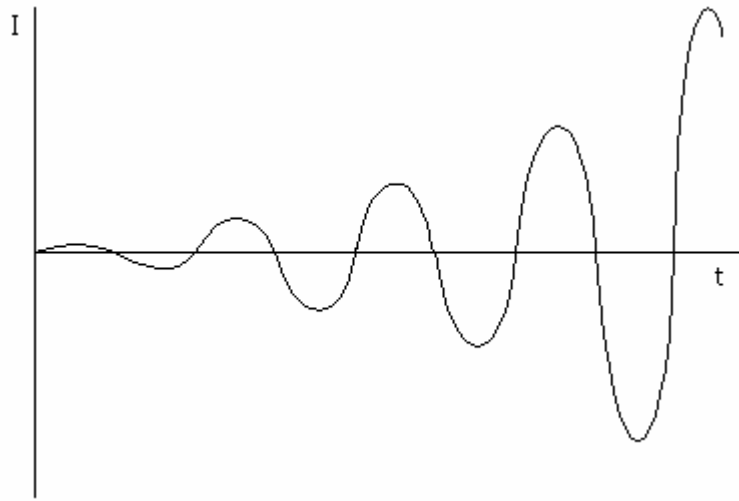
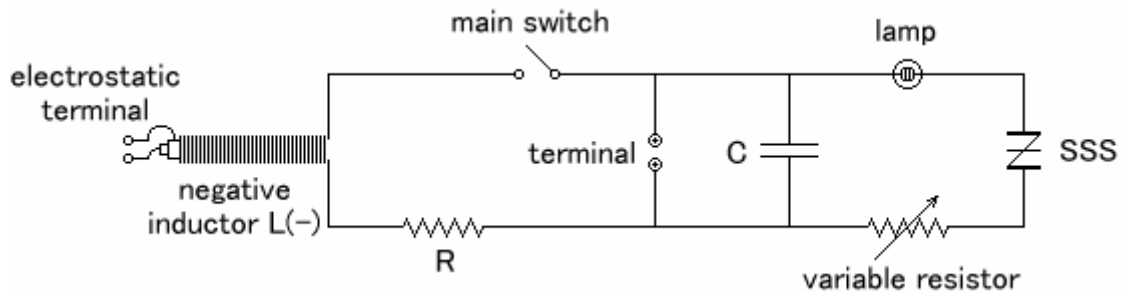

Figure 13. increased oscillation

Provided that the imaginary current of I (A) flows for t seconds as our real time in a circuit which has resistance of R the heat quantity H (J) generating from the circuit should be negative according to the Joule's law, $H = I^2 R t$.

In the RLC series circuit whose total inductance is negative because of the Negative Inductor, an imaginary current with the increased oscillation flows. By this imaginary current, the circuit is cooled down.

Figure 15 is an experimental circuit to generate the electric power. The use of the symmetric silicon switch (**SSS**) whose breakover voltage is about 60 V, prevents high voltage, electric discharges and short-circuits, and provides the stable output.



The actual experimental machine is mentioned in **Figure 16**.

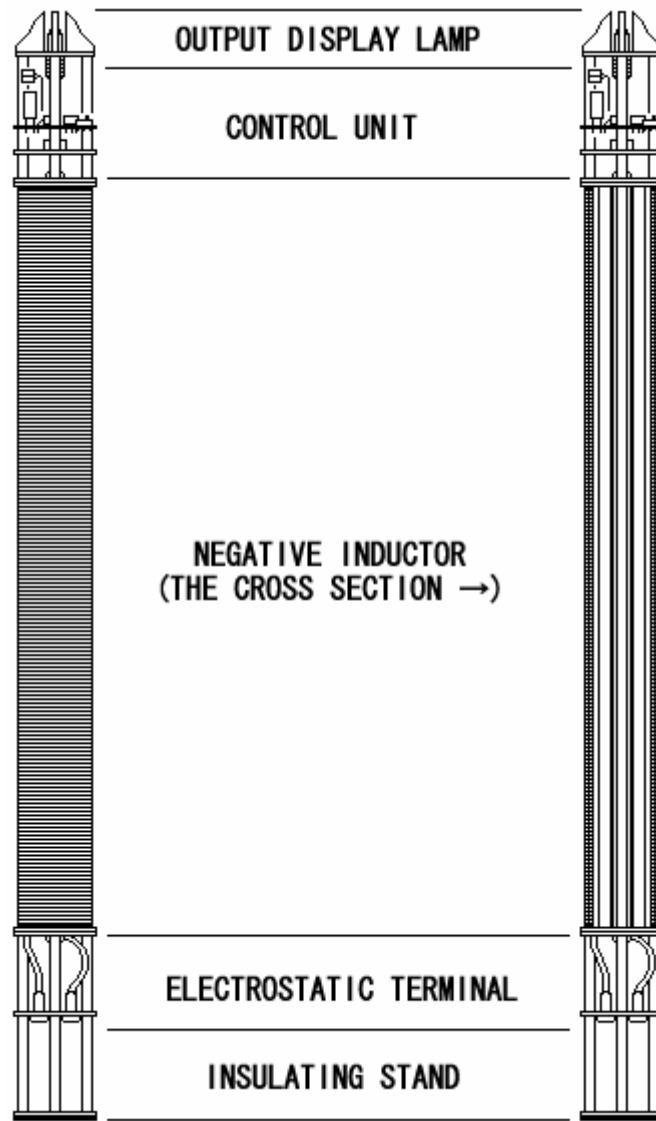

Figure 16. - SELF-EXCITED GENERATOR



CONCLUSION

The self-induction phenomenon brought by the acceleration of the electric charges is a relative phenomenon occurring by the relative acceleration between these and other electric charges. When the relative acceleration exist between the same kind of electric charges, the negative energy can be stored in the relative magnetic field. In applying the phenomenon, the negative inductor can be made. It is possible to make the negative inductor easily by electrifying the back of the non-inductive coil into negative.